

MBC 智能型 RS-485 資料交換器

特點：

- ▶ 智能型 Modbus RTU 主/從式交換介面
- ▶ 可以同時連接多部相同通信格式裝置，接收/傳送
- ▶ USB 介面搭配免費軟體規劃，不需另外編輯程式語言
- ▶ 支援 RS-485 N81, N82, O81, E81 通信格式

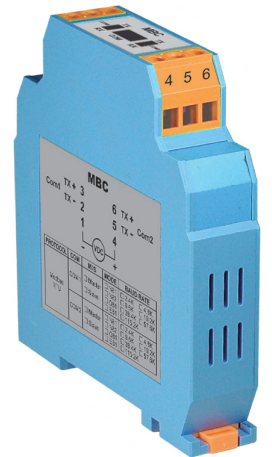
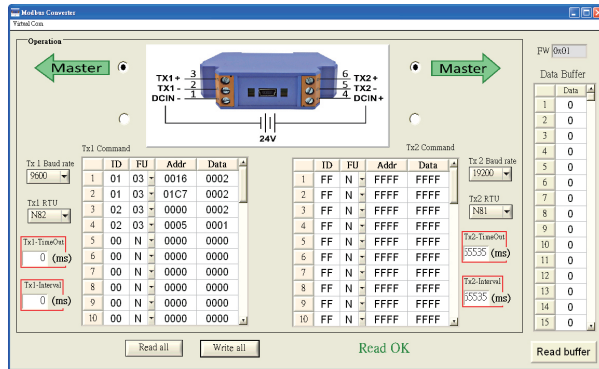
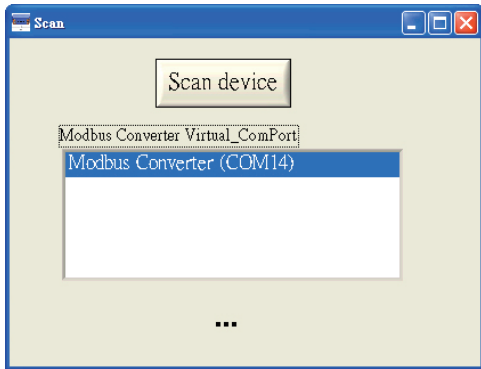

規格說明	
COM1/COM2	通信協議：Modbus RTU
	通信格式：N,8,1；N,8,2；O,8,1；E,8,1
	Baud Rate：2400, 4800, 9600, 19200, 38400, 57600, 115200
	主動式/被動式 讀寫模式
反應時間	20~2000 ms
共模拒斥比 (CMRR)	> 80 dB
電磁相容性	En 50081-2, En 50082-2
隔離	2.8 KV. between input and output
電源	DC18~36V
消耗電力	1.7W (max)
操作溫度	-10 to 50°C
溼度	0 to 90% RH
尺寸	75mm(W)x87mm(H)x18.5mm(D)

外觀尺寸

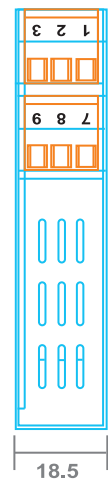
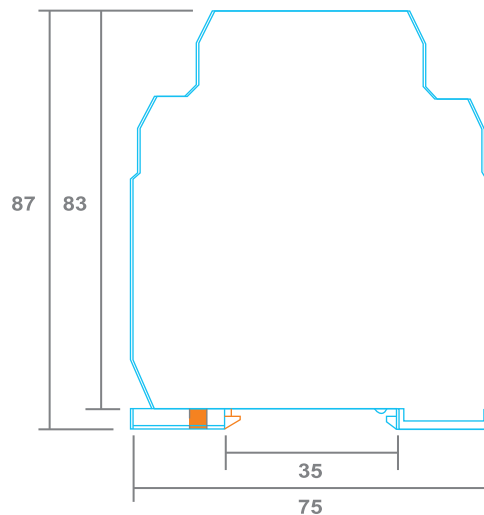

(單位：mm)

配線圖

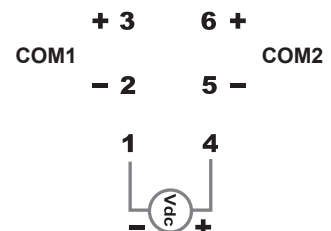
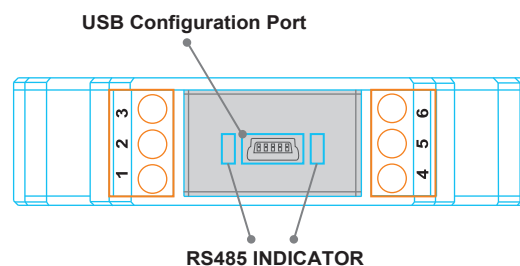

1. COM1主動收集，COM2主動傳送

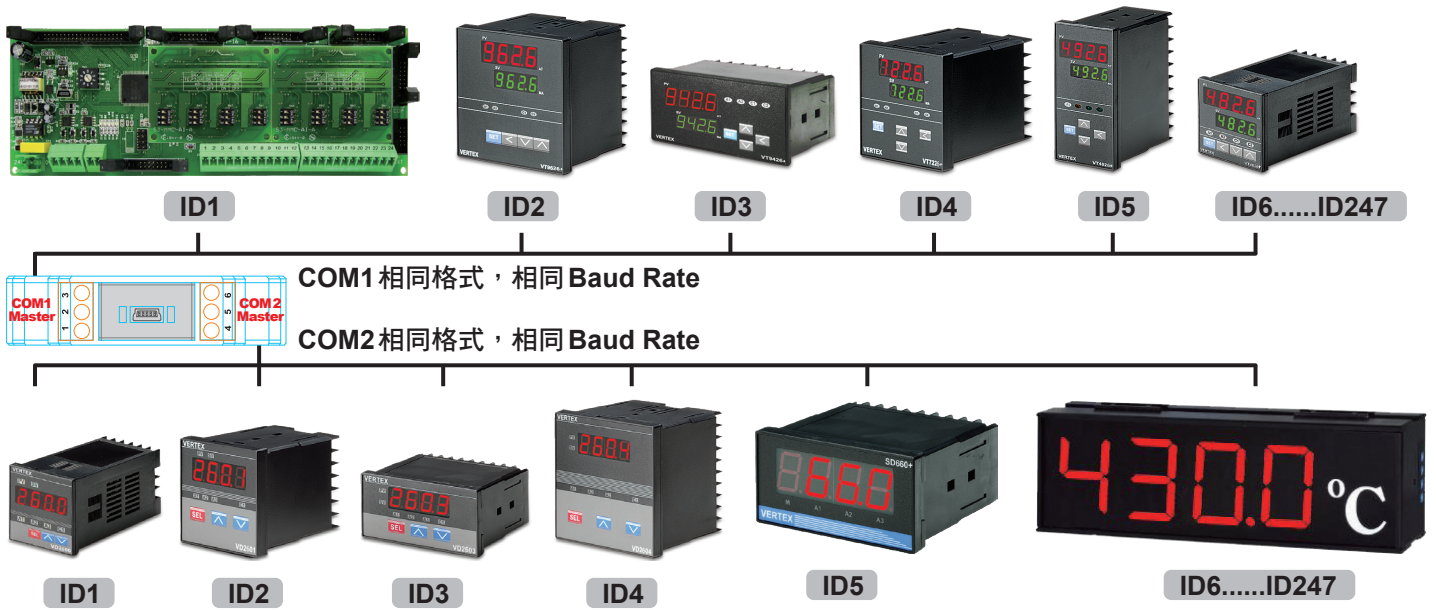

2. COM1主動收集，COM2被動接收 PLC/PC 指令傳送資料，將各個不同格式資料整合為相同格式，以便後端 PLC/PC..... 讀取及接收

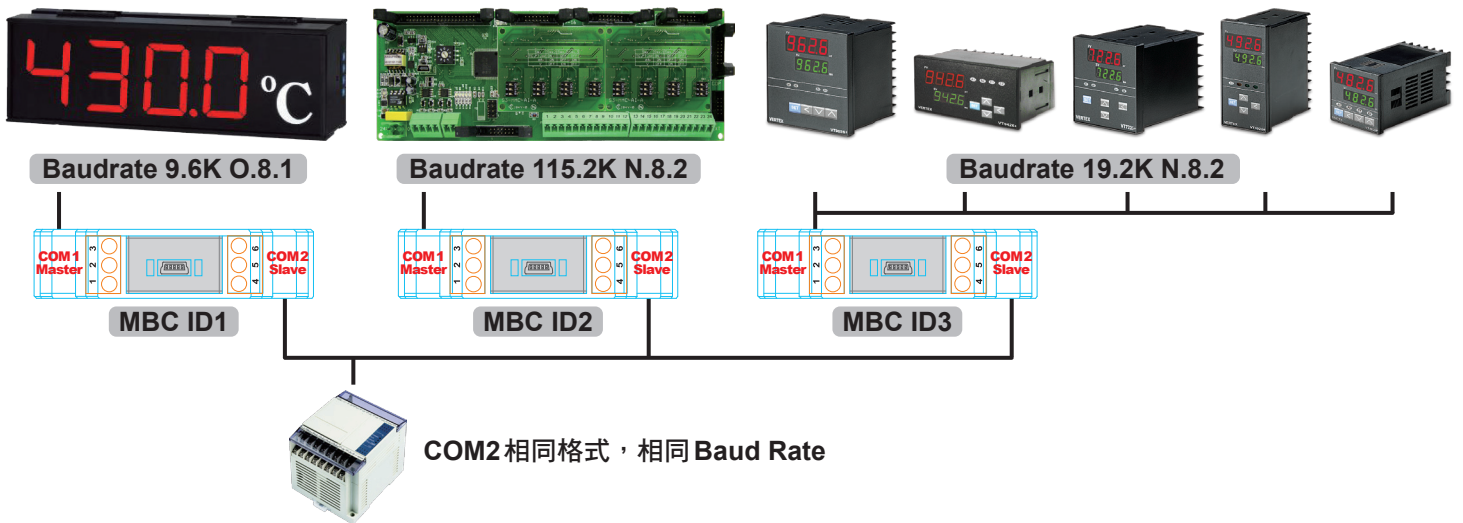

3. 通信分配器應用一進二出

